

FAULT IDENTIFICATION IN UNDERWATER VEHICLE THRUSTERS VIA SLIDING MODE OBSERVERS

ALEXANDER ZUEV ^{a,c}, ALEXEY ZHIRABOK ^{b,c,*}, VLADIMIR FILARETOV ^a

^aInstitute of Automation and Control Processes
Russian Academy of Sciences—Far Eastern Branch
5 Radio Street, Vladivostok, 690041, Russia
e-mail: {zuev@dvo.ru, filaretov}@inbox.ru

^bDepartment of Automation and Control
Far Eastern Federal University
8 Sukhanova Street, Vladivostok, 690091, Russia
e-mail: zhirabok@mail.ru

^cInstitute for Marine Technology Problems
Russian Academy of Sciences—Far Eastern Branch
5 Sukhanova Street, Vladivostok, 690091, Russia

The paper is devoted to the problem of increasing the efficiency of underwater vehicles by using a fault diagnosis system for their thrusters which provides detection, isolation, and identification of minor faults. To address the problem, a two-stage method is proposed. At the first stage, a bank of diagnostic observers is designed to detect and isolate the emerging faults. Each observer in this bank is constructed to be sensitive to some set of faults and insensitive to others. At the second stage, additional observers working in sliding mode are synthesized in order to accurately estimate the error value in the signal obtained from the angular velocity sensor and to estimate deviations of the thruster parameters from their nominal values due to the faults. In contrast to the existing solutions, reduced-order (i.e., lower-dimensional) models of the original system are proposed as a basis to construct sliding mode observers. This approach permits reduction of the complexity of the obtained observers in comparison with the known methods, where full-order observers are constructed. The simulation results show the efficiency and high quality of all synthesized observers. In all cases considered, it was possible to detect typical faults, as well as estimate their values.

Keywords: underwater vehicles, thrusters, fault identification, sliding mode observers.

1. Introduction

One of the most important tasks arising during various missions is ensuring their safety and fault tolerance. A promising way to increase the efficiency of the UV operation is the use of fault diagnosis methods (Blanke *et al.*, 2006; Mironovsky, 1998; Escobet *et al.*, 2019) for fault detection and isolation as well as fault identification (Simani *et al.*, 2002; Byrski *et al.*, 2019). These methods provide accurate estimates of the error values in the signals received from sensors and estimates of the deviations of the UV thruster parameters from

their nominal values due to faults. Then the obtained estimates can be used to eliminate the consequences of the appearing faults (Blanke *et al.*, 2006; Filaretov *et al.*, 2012) (this is called accommodation to these faults).

Thrusters of the UVs, providing their motion along prescribed trajectories, are such UV components which influence their ability to perform assigned tasks. The appearance of any faults that is caused by failures or changes in the thruster parameters may lead to a significant decrease in the performance of the UV control, various emergency situations, or even a loss of expensive devices. In this paper, the regarded UVs have no other actuators except thrusters and both movement and

*Corresponding author

positioning are realized only by changes in the developed thrusts.

It is assumed that the following typical faults can appear in each thruster: (i) a fault in the angular velocity sensor resulting in a constant or variable error in its readings; (ii) the heating of the motor or closing several windings of its armature circuit resulting in a change in the nominal value of electrical resistance; (iii) an unknown external torque effect on the output motor shaft, caused by plants tangled over a screw propeller.

At present, in order to assess the technical condition of various elements, the UVs are equipped with alarm control systems whose tasks include identifying the critical and emergency situations (Chirikjian, 2009; Pisarets *et al.*, 2004). However, as a rule, the existing alarm systems provide only general monitoring of operability and do not allow to detect the faults, as well as to evaluate errors in the thruster sensors readings and the deviations of the UV thruster parameters from their nominal values.

Currently, there are several approaches to construct systems dedicated to the diagnosis of UV thrusters. In particular, methods based on constructing observers using UV dynamic models are presented by Zhang *et al.* (2011), Zhu and Sun (2013), Wang (2012a) as well as Zhao *et al.* (2014). However, since the UVs are described by very complex nonlinear differential equations with variable and uncertain parameters, such systems for diagnosis are rather complex and do not yield high-quality fault detection and identification if the UVs are in high-speed motion. In addition, many of these methods require the use of special test motions of the UV movement (Zhao *et al.*, 2014).

There are interesting diagnosis methods based on neural networks (Wang *et al.*, 2009; Wang, 2012b). A disadvantage of these methods is the necessity for a complex training procedure by using also special test motions of the UVs.

Sarkar *et al.* (2002) considered the approach to construct a fault diagnosis and accommodation system in the UV thrusters was. This approach suggests disconnection of the faulty thruster and the subsequent distribution of its power between the remaining thrusters. A disadvantage of this approach is the fact that UVs must be equipped with an excessive number of the thrusters.

Currently, one of the promising approaches to fault detection and identification is the use of the observers operating in a sliding mode (Utkin, 1992) (sliding mode observers, SOs). Nowadays, the SOs are applied to solve the problems of fault identification in linear (Edwards and Spurgeon, 1994; Fridman *et al.*, 2007; Edwards *et al.*, 2000) and nonlinear (Davila *et al.*, 2006; He and Zhang, 2012; Rascón *et al.*, 2017) systems, to ensure fault-tolerant control (Edwards *et al.*, 2012; Alwi and Edwards, 2008; Bartoszewicz and Adamiak, 2019).

However, in all these papers, a number of restrictions are imposed on the original system and full-order observers are constructed.

Besides, to solve the problem of sensor fault identification, the methods suggested by Tan and Edwards (2003) and similar papers assume that a new state vector being a filtered version of the system output is introduced and a special system of a larger dimension is constructed. The methods suggested by Edwards *et al.* (2000) and Kalsi *et al.* (2011) provide only approximate solutions of the sensor fault identification problem since the final expressions contain the derivative of the sensor fault. These reasons make the procedure of the accurate fault identification in the UV thrusters and sensors rather complicated.

As a result, most of above-mentioned methods cannot be effectively used for the purpose of constructing the fault diagnosis system for the UV thrusters. Thus, the task of developing a new easily implemented and effective method for constructing fault diagnosis systems for the UV thrusters remains unresolved and topical. Such systems must provide both fault detection and isolation, as well as identification of the error values in the signals received from the UV thruster sensors, and the deviations of the thruster parameters from their nominal values due to faults.

Problem statement. Construct a bank of diagnostic observers to solve the task of fault isolation based on the structural residual vector and the matrix of syndromes and then construct a bank of sliding mode observers based on the reduced order model of the original system invariant with respect to the disturbance to estimate the error values in the signals received from the UV thruster sensors and estimate the deviations of the UV thruster parameters from their nominal values.

The contribution of the present paper can be summarized as follows. (i) Sliding mode observers for fault identification are constructed based on a reduced-order model of the original system invariant with respect to the disturbance. The reduced order model may be free from some special features of the original system preventing sliding mode observer design. (ii) To solve the problem of sensor fault identification, the suggested approach allows construction of the sliding mode observer of a reduced dimension which does not contain the derivative of the sensor fault. The known papers which solve this problem construct sliding mode observers containing the derivative of the sensor fault or having a dimension a greater than that of the original system. Our previous papers (Zhirabok *et al.*, 2019; 2020a; 2020b) consider systems described by linear models; the present paper operates with nonlinear models containing arbitrary nonlinear functions.

The rest of the paper is organized as follows. In

Section 2, the reduced order models are constructed. Section 3 is devoted to sliding mode observer design. In Section 4, the problem of fault isolation is studied. The fault diagnosis system for the UV thruster is designed in Section 5. Section 6 concludes the paper.

2. Reduced order model design

Each UV thruster can be described by nonlinear dynamic model

$$\begin{aligned} \dot{x}(t) &= Fx(t) + Gu(t) + C\Psi(x(t), u(t)) \\ &\quad + Dd(t) + L\rho(t), \\ y(t) &= Hx(t) + D_s d_s(t), \end{aligned} \quad (1)$$

where $x(t) \in \mathbb{R}^n$, $u(t) \in \mathbb{R}^m$, $y(t) \in \mathbb{R}^n$ are vectors of state, control, and output, respectively, $F \in \mathbb{R}^{n \times n}$, $G \in \mathbb{R}^{n \times m}$, $H \in \mathbb{R}^{l \times n}$, $C \in \mathbb{R}^{n \times q}$, and $L \in \mathbb{R}^{n \times p}$ are, constant matrices; $D \in \mathbb{R}^{n \times 1}$ and $d(t) \in \mathbb{R}$ are, respectively, a constant matrix and a function describing unmatched actuator faults: if there are no faults, $d(t) = 0$, if a fault occurs, $d(t)$ becomes an unknown bounded function of time; $D_s \in \mathbb{R}^{l \times 1}$ and $d_s(t) \in \mathbb{R}$ are respectively, a matrix and a function describing sensor faults: if there are no faults, $d_s(t) = 0$; if a fault occurs, $d_s(t)$ becomes an unknown bounded function of time; $\rho(t) \in \mathbb{R}^p$ is the disturbance; it is assumed that $\rho(t)$ is an unknown bounded function of time; $\Psi(x, u)$ is a nonlinear term,

$$\Psi(x, u) = \begin{pmatrix} \varphi_1(A_1 x, u) \\ \vdots \\ \varphi_q(A_q x, u) \end{pmatrix},$$

$A_1, \dots, A_q \in \mathbb{R}^{1 \times n}$ are constant row matrices, $\varphi_1, \dots, \varphi_q$ are arbitrary nonlinear functions.

Note that the UVs have many different sensors; in particular, there are sensors in thrusters. The most beneficial case for fault diagnosis is when all components of the state vector $x(t)$ are measured. This case is interesting *per se* since it allows us to construct a fault diagnosis system of a minimal complexity and save computational resources of the UV on-board computer. Therefore, in what follows we will assume that $H = I$, i.e., H is the identity matrix.

As pointed out in the Introduction, diagnostic observers and sliding mode observers will be constructed based on a reduced-order model of the original system invariant with respect to the disturbance and some faults. It is known (Zhirabok *et al.*, 2019; 2020a) that such a model is generally described by the equations

$$\begin{aligned} \dot{x}_*(t) &= F_* x_*(t) + G_* u(t) + J_* H x(t) + D_* d(t) \\ &\quad + C_* \Psi(x_*(t), y(t), u(t)) + L_* \rho(t), \\ y_*(t) &= H_* x_*(t) + D_{*s} d_s(t), \end{aligned} \quad (2)$$

where $x_*(t) \in \mathbb{R}^k$, $k < n$, is the state vector, $F_* \in \mathbb{R}^{k \times k}$, $G_* \in \mathbb{R}^{k \times m}$, $J_* \in \mathbb{R}^{k \times l}$, $H_* \in \mathbb{R}^{1 \times k}$, $D_* \in \mathbb{R}^{k \times 1}$, $D_{*s} \in \mathbb{R}$, and $L_* \in \mathbb{R}^{k \times p}$ are matrices to be determined,

$$C_* \Psi(x_*, y, u) = \begin{pmatrix} \varphi_{i_1}(A_{*1i_1} x_* + A_{*2i_1} y, u) \\ \vdots \\ \varphi_{i_k}(A_{*1i_k} x_* + A_{*2i_k} y, u) \end{pmatrix},$$

$A_{*1i_1}, \dots, A_{*1i_k} \in \mathbb{R}^{1 \times k}$, $A_{*2i_1}, \dots, A_{*2i_k} \in \mathbb{R}^{1 \times l}$ are row matrices to be determined.

We assume that $x_*(t) = \Phi x(t)$ and $y_*(t) = R_* y(t)$ for some matrices $\Phi \in \mathbb{R}^{k \times n}$ and $R_* \in \mathbb{R}^{1 \times l}$ under $d(t) = 0$, $d_s(t) = 0$, and $\rho(t) = 0$. It is known (Zhirabok *et al.*, 2017) that these matrices satisfy the conditions

$$\begin{aligned} \Phi F &= F_* \Phi + J_* H, \\ R_* H &= H_* \Phi, \quad \Phi G = G_*, \\ A_i &= (A_{*1i} \ A_{*2i}) \begin{pmatrix} \Phi \\ H \end{pmatrix}, \quad i = i_1, \dots, i_k, \\ \Phi C &= C_*, \quad \Phi D = D_*, \\ \Phi L &= L_*, \quad R_* D_s = D_{*s}. \end{aligned} \quad (3)$$

The matrices F_* and H_* are sought in the canonical form

$$\begin{aligned} F_* &= \begin{pmatrix} 0 & 1 & 0 & \dots & 0 \\ 0 & 0 & 1 & \dots & 0 \\ \dots & \dots & \dots & \dots & \dots \\ 0 & 0 & 0 & \dots & 0 \end{pmatrix}, \\ H_* &= (1 \ 0 \ 0 \ \dots \ 0). \end{aligned} \quad (4)$$

Using the matrices F_* and H_* in (4), we obtain from (3) equations for the rows of the matrices Φ and J_* :

$$\begin{aligned} \Phi_1 &= R_* H, \\ \Phi_i F &= \Phi_{i+1} + J_{*i} H, \quad i = 1, \dots, k-1, \\ \Phi_k F &= J_{*k} H, \end{aligned}$$

where Φ_i and J_{*i} are the i -th rows of the matrices Φ and J_* , respectively, $i = 1, \dots, k$, k is the dimension of the model (2).

Clearly, when $H = I$, the minimal dimension of the reduced order model is equal to one. This implies $F_* = 0$ and $H_* = 1$ in (2). It is known (Zhirabok *et al.*, 2019; 2020a) that to construct system (2) invariant with respect to the disturbance, the condition $\Phi L = 0$ should be satisfied. To take into account this condition, introduce the matrix L^0 of a maximal rank such that $L^0 L = 0$, then $\Phi = N L^0$ for some matrix N . It follows from $R_* H = H_* \Phi$, $H_* = 1$, and $H = I$ that $R_* = \Phi = N L^0$. Next, $\Phi F = F_* \Phi + J_* H$ is transformed into $J_* = N L^0 F$. Then

$$G_* = N L^0 G, \quad C_* = N L^0 C, \quad D_* = N L^0 D.$$

The choice of the matrix N may be conditioned by different reasons. Let, for example, two faults be possible

in system (1) and be represented by the sum $D_1d_1(t) + D_2d_2(t)$ instead of the term $Dd(t)$. To construct the model (2) insensitive to the first fault, introduce the matrix $L_1 = (L \ D_1)$ and the matrix L_1^0 of the maximal rank such that

$$L_1^0 L_1 = 0. \tag{5}$$

Then

$$\begin{aligned} R_* &= \Phi = N_1 L_1^0, & J_* &= N_1 L_1^0 F, \\ G_* &= N_1 L_1^0 G, & C_* &= N_1 L_1^0 C, \\ D_* &= N_1 L_1^0 D \end{aligned} \tag{6}$$

for some matrix N_1 .

Clearly, from $H = I$ it follows that we may set $A_{*1i} := 0$ for all i ; to obtain the matrices A_{*2i} , assume that $C_* \Psi(x_*, y, u)$ contains the functions $\varphi_{i_1}, \dots, \varphi_{i_k}$; then A_{*2i} can be found as $A_{*2i} = A_i, i = i_1, \dots, i_k$, which follows from (3) under $H = I$ and $A_{*1i} = 0$. Rewrite the term $C_* \Psi(x_*, y, u)$ in the form $\Psi_*(y, u)$. As a result, the model (2) takes the form

$$\begin{aligned} \dot{x}_*(t) &= G_* u(t) + J_* y(t) + D_* d(t) \\ &\quad + \Psi_*(y(t), u(t)), \\ y_*(t) &= x_*(t) + D_{*s} d_s(t). \end{aligned} \tag{7}$$

3. Sliding mode observer design

3.1. Actuator faults. Assume that $D_s = 0$. The sliding mode observer is based on the model (7) and takes the form

$$\begin{aligned} \dot{\hat{x}}_*(t) &= G_* u(t) + J_* y(t) + v(t) \\ &\quad + \Psi_*(y(t), u(t)) - K e_y(t), \\ \hat{y}_*(t) &= \hat{x}_*(t), \end{aligned} \tag{8}$$

where the discontinuous function $v(t)$ is given by

$$v(t) = \begin{cases} -g|D_*| \frac{e_y(t)}{|e_y(t)|} & \text{if } e_y(t) \neq 0, \\ 0 & \text{otherwise,} \end{cases}$$

$$\begin{aligned} e_y(t) &= \hat{y}_*(t) - y_*(t) = \hat{y}_*(t) - R_* y(t), \\ &= e(t) = \hat{x}_*(t) - x_*(t), \end{aligned}$$

$K > 0$ is the feedback coefficient guaranteeing the observer stability. Using (7) and (8), we write down the equation for the error $e(t)$:

$$\dot{e}(t) = v(t) - D_* d(t) - K e(t). \tag{9}$$

Theorem 1. *If the scalar g satisfies $g > |d(t)|$, then the sliding motion of system (9) is asymptotically stable.*

Proof. Consider the Lyapunov function

$$V(t) = e^2(t)$$

and find its derivative with respect to time:

$$\begin{aligned} \dot{V}(t) &= 2(v(t) - D_* d(t) - K e(t))e(t) \\ &= -2K e^2(t) - 2g|D_*|e(t) \frac{e(t)}{|e(t)|} \\ &\quad - 2e(t)D_* d(t) \\ &\leq -2K e^2(t) - 2g|D_*||e(t)| \\ &\quad + 2|e(t)||D_*||d(t)| \\ &= -2K e^2(t) - 2|D_*||e(t)|(g - |d(t)|). \end{aligned}$$

Since $g > |d(t)|$, we have $\dot{V}(t) < 0$, which completes the proof. ■

According to Edwards *et al.* (2000), the discontinuous function $v(t)$ in (9) can be approximated to any degree of accuracy by the equivalent output injection function

$$v_{eq} = -g|D_*| \frac{e_y(t)}{|e_y(t)| + \delta}, \tag{10}$$

where δ is a small positive scalar.

It is known (Edwards *et al.*, 2000) that the sliding motion takes place forcing $\dot{e}(t) = 0$ and $e(t) = 0$; therefore (9) implies $v_{eq}(t) - D_* d(t) = 0$. Then the function $d(t)$ can be estimated in the form

$$\hat{d}(t) = -\text{sign}(D_*) \frac{g e_y(t)}{|e_y(t)| + \delta}.$$

3.2. Sensor faults. Assume that $D = 0$. To construct the SO estimating sensor faults, the condition $R_* D_s = 0$ should be satisfied as otherwise no sliding motion can be obtained (Zhirabok *et al.*, 2020b). To take into account this condition, introduce the matrix $L_s = (L \ D_s)$ and the matrix L_s^0 of a maximal rank such that $L_s^0 L_s = 0$. Then, by analogy with (6), $R_* = \Phi = N_s L_s^0, J_* = N_s L_s^0 F, G_* = N_s L_s^0 G$, and $C_* = N_s L_s^0 C$ for some matrix N_s .

The choice of the matrix N_s may be conditioned by different reasons. Let two sensor faults be possible in system (1) and be represented by the sum $D_{s1}d_{s1}(t) + D_{s2}d_{s2}(t)$ instead of the term $D_s d_s(t)$. To construct the model (2) insensitive to the first fault, introduce the matrix D_{s1}^0 of a maximal rank such that $D_{s1}^0 D_{s1} = 0$. Then $J_* = M_1 D_{s1}^0$ for some matrix M_1 . As a result, the equation $J_* = N_s L_s^0 F$ is transformed into $M_1 D_{s1}^0 = N_s L_s^0 F$ which can be rewritten in the form

$$\begin{pmatrix} M_1 \\ -N_s \end{pmatrix} \begin{pmatrix} D_{s1}^0 \\ L_s^0 F \end{pmatrix} = 0. \tag{11}$$

This equation has a solution if and only if

$$\text{rank} \begin{pmatrix} D_{s1}^0 \\ L_s^0 F \end{pmatrix} < \text{rank}(D_{s1}^0) + \text{rank}(L_s^0 F). \tag{12}$$

If (12) is true, the matrix M_1 is found from (11).

As above, the term $C_*\Psi(x_*, y, u)$ is in the form $\Psi_*(y, u)$. Assume for simplicity that the output y_j corresponding to the faulty sensor does not enter the nonlinear term $\Psi_*(y, u)$. As a result, the model (2) takes the form

$$\begin{aligned}\dot{x}_*(t) &= G_*u(t) + J_*x(t) + \Psi_*(y(t), u(t)), \\ y_*(t) &= x_*(t).\end{aligned}\quad (13)$$

Since $y(t) = x(t) + D_s d_s(t)$, the sliding mode observer takes the form

$$\begin{aligned}\dot{\hat{x}}_*(t) &= G_*u(t) + J_*y(t) + v(t) \\ &\quad + \Psi_*(y(t), u(t)) - Ke_y(t) \\ &= G_*u(t) + J_*x(t) + J_*D_s d_s(t) + v(t) \\ &\quad + \Psi_*(y(t), u(t)) - Ke_y(t), \\ \hat{y}_*(t) &= \hat{x}_*(t).\end{aligned}$$

The equation for the error $e(t) = \hat{x}_*(t) - x_*(t)$ is in the form

$$\dot{e}(t) = v(t) + J_*D_s d_s(t) - Ke(t), \quad (14)$$

where the function $v(t)$ is given by

$$v(t) = \begin{cases} -g|J_*D_s| \frac{e_y(t)}{|e_y(t)|} & \text{if } e_y(t) \neq 0, \\ 0 & \text{otherwise,} \end{cases} \quad (15)$$

$e_y(t) = \hat{y}_*(t) - R_*y(t)$. Since $R_* = \Phi$ and $R_*D_s = 0$, we get

$$\begin{aligned}e_y(t) &= \hat{y}_*(t) - R_*y(t) \\ &= \hat{x}_*(t) - R_*(x(t) + D_s d_s(t)) \\ &= \hat{x}_*(t) - \Phi x(t) + R_*D_s d_s(t) = e(t).\end{aligned}$$

Theorem 2. *If the scalar g satisfies $g > |d_s(t)|$, then the sliding motion of system (14) is asymptotically stable.*

Proof. It is similar to the proof of Theorem 1 since the relation (9) is similar to (14). ■

As above, the discontinuous function $v(t)$ in (14) can be approximated by an equivalent output injection function $v_{eq}(t)$ similar to (10). As a result, the function $d_s(t)$ is estimated as

$$\hat{d}_s(t) = \text{sign}(J_*D_s) \frac{ge_y(t)}{|e_y(t)| + \delta}.$$

4. Fault isolation

Assume that the matrix L_1^0 from (5) does not exist or the condition (12) is not satisfied for some faults. This means that some faults cannot be decoupled from one another. In this case, a fault isolation procedure based on a bank of diagnostic observers (DOs) should precede the fault identification procedure. Each observer from such a bank

is constructed based on the model (7) or (13) sensitive to some group of faults and insensitive to others. Each observer generates a residual as a mismatch between the transformed output $R_*y(t)$ of the original system and the output $y_*(t)$ of the DO:

$$r(t) = R_*y(t) - y_*(t).$$

The description of the DO based on the model (7) is

$$\begin{aligned}\dot{x}_*(t) &= G_*u(t) + J_*y(t) + \Psi_*(y(t), u(t)) \\ &\quad + K_D r(t), \\ y_*(t) &= x_*(t),\end{aligned}$$

where $K_D > 0$ is a feedback coefficient ensuring the stability of the observer.

The decision about faults is made based on the matrix of syndromes S (Gertler, 1998); the rows of this matrix correspond to residuals and the columns to faults.

Note that it is reasonable to use a fault isolation procedure even if the matrix L_1^0 exists and the condition (12) is satisfied for all faults. The reason is that the number of the DOs is less than that of the SOs and the previous fault isolation allows us to save computational resources of the UV onboard computer.

5. Fault diagnosis system design

As noted above, the UV thruster is presented by the DC motor with angular velocity and current sensors (Filaretov et al., 2012):

$$\begin{aligned}\dot{x}_1(t) &= -\frac{k_v}{J}x_1(t) + \frac{k_m}{J}x_2(t) - \frac{M(t)}{J} + d_1(t), \\ \dot{x}_2(t) &= -\frac{k_w}{L_m}x_1(t) - \frac{R_m}{L_m}x_2(t) + \frac{k_u}{L_m}u(t) + d_2(t), \\ y_1(t) &= x_1(t) + d_s(t), \\ y_2(t) &= x_2(t),\end{aligned}\quad (16)$$

where $x_1(t) = \omega(t)$ is the rotor angular speed, $x_2(t) = I(t)$ is the current through the armature circuit of the electric motor; k_v is the coefficient of viscous friction; J is the moment of inertia of rotating parts of the thruster, taking into account the connected moment of inertia of the fluid, R_m and L_m are the resistance and inductance of the armature circuit of the motor, respectively; k_w is the coefficient of counter-EMF; k_u is the gain of the electric amplifier; k_m is the torque coefficient; $M(t) = (k_1 + k_2\lambda + k_3\lambda^2 + k_4\lambda^3)\rho|\omega(t)|\omega(t)D^5$ is the load moment due to the action of a viscous environment on the screw propeller; ρ is the density of water; D is the propeller diameter; $\lambda(t) = \eta(t)/(\omega(t)D)$, $\eta(t)$ is the UV velocity; k_1, \dots, k_4 are known constant coefficients; $u(t)$ is the voltage at the input of the power amplifier.

Note that such a model with a load moment $M(t)$ is successfully used in the Institute of Marine Technology Problems (Far Eastern Branch of the Russian Academy of Sciences) in practical applications (Inzarcev et al., 2018); this model is based on the paper by Daidola and Johnson (1992). Note that such a model was comprehensively tested during numerous experiments with UVs designed and produced by the Institute of Marine Technology Problems.

Clearly, the thruster is described by the following matrices:

$$\begin{aligned}
 F &= \begin{pmatrix} -\frac{k_v}{J} & \frac{k_m}{J} \\ -\frac{k_w}{L_m} & -\frac{R_m}{L_m} \end{pmatrix}, \\
 G &= \begin{pmatrix} 0 \\ \frac{k_u}{L_m} \end{pmatrix}, \\
 D_1 &= \begin{pmatrix} 1 \\ 0 \end{pmatrix}, \\
 D_2 &= \begin{pmatrix} 0 \\ 1 \end{pmatrix}, \quad D_s = \begin{pmatrix} 1 \\ 0 \end{pmatrix}, \\
 C &= \frac{1}{J}, \quad \Phi(x(t), (t)) = M(t).
 \end{aligned}$$

It is assumed that when a UV operates autonomously, the following typical faults may occur in its thrusters: (i) a fault in the speed sensor, leading to the appearance of a constant or a variable error $d_s(t) = \tilde{\omega}(t)$ in its readings; (ii) the fault $d_1(t) = -\tilde{M}(t)/J$, corresponding to the appearance of an additional external torque effect $\tilde{M}(t)$ on the motor shaft, caused, for example, by plants tangled over a screw propeller; (iii) the fault $d_2(t) = -\tilde{R}(t)I(t)/L_m$, corresponding to the motor overheating or shorting several turns of the armature winding that leads to a deviation $\tilde{R}(t)$ of the electrical resistance R_m from its nominal value. The presence of these faults significantly reduces the performances of the thrusters and the accuracy of the UV movement along the prescribed paths.

During the operation of the UV (especially in stand-alone modes), each fault in any thruster, regardless of the reason of its appearance, should be timely detected and its influence on the thruster work should be eliminated.

Thus, in this section we construct a fault diagnosis system for the UV thrusters that ensures timely detection and isolation of the emerging faults (i.e., determining the fact and time of appearance of nonzero functions $d_1(t)$, $d_2(t)$, and $d_s(t)$ in system (16)), as well as identification of the error value $\tilde{\omega}(t)$ in the signals received from the speed sensor, and the deviations $\tilde{R}(t)$ and $\tilde{M}(t)$.

Assume for simplicity that the disturbance $\rho(t)$ is small and one may let $L = 0$. Construct the reduced order model which is invariant with respect to the function $d_1(t)$. Since $L = 0$, we have $L_1 = D_1$ and $L_1^0 = (0 \ 1)$.

As a result, $R_* = \Phi = L_1^0 = (0 \ 1)$ and

$$\begin{aligned}
 J_* &= L_1^0 F = \begin{pmatrix} -\frac{k_w}{L_m} & -\frac{R_m}{L_m} \end{pmatrix}, \\
 G_* &= \frac{k_u}{L_m}, \quad D_* = 1,
 \end{aligned}$$

and the reduced-order model is given by

$$\begin{aligned}
 \dot{x}_*(t) &= -\frac{k_w}{L_m}y_1(t) - \frac{R_m}{L_m}y_2(t) + \frac{k_u}{L_m}u(t) + d_2(t), \\
 y_*(t) &= x_*(t),
 \end{aligned} \tag{17}$$

where $x_* = x_2$.

By analogy, the model which is invariant with respect to the function $d_2(t)$ is given by

$$\begin{aligned}
 \dot{x}_*(t) &= -\frac{k_v}{J}y_1(t) + \frac{k_m}{J}y_2(t) - \frac{M(t)}{J} + d_1(t), \\
 y_*(t) &= x_*(t),
 \end{aligned} \tag{18}$$

where $x_* = x_1$.

The first diagnostic observer is constructed based on the model (17) and takes the form

$$\begin{aligned}
 \dot{x}_*(t) &= -\frac{k_w}{L_m}y_1(t) - \frac{R_m}{L_m}y_2(t) + \frac{k_u}{L_m}u(t) + r_1(t), \\
 y_*(t) &= x_*(t), \\
 r_1(t) &= y_2(t) - y_*(t).
 \end{aligned} \tag{19}$$

For simplicity, we keep the same notation for the state and output variables as in (17). The description of the second diagnostic observer is omitted because it is based on (18) and evident.

Since both models (17) and (18) contain the variable $y_1(t)$, they are sensitive to the function $d_s(t)$. Therefore, the matrix of syndromes is of the form

$$S = \begin{pmatrix} 0 & 1 & 1 \\ 1 & 0 & 1 \end{pmatrix}$$

that allows to distinguish all faults from one another. Here the rows correspond to residuals $r_1(t)$ and $r_2(t)$, the columns to the faults $d_1(t)$, $d_2(t)$, and $d_s(t)$.

The first sliding mode observer SO1 is constructed based on the model (17) and takes the form

$$\begin{aligned}
 \dot{\hat{x}}_*(t) &= -\frac{k_w}{L_m}y_1(t) - \frac{R_m}{L_m}y_2(t) + \frac{k_u}{L_m}u(t) \\
 &\quad + v_{eq}(t) - 0.1e_1(t), \\
 \hat{y}_*(t) &= \hat{x}_*(t), \\
 e_1(t) &= \hat{y}_*(t) - y_2(t).
 \end{aligned} \tag{20}$$

The function $v_{eq}(t)$ is given by (10) with $D_* = 1$ and $g > |d_2(t)|$. The function $\hat{R}(t) = -L_m d_2(t)/I(t)$ can be estimated as

$$\hat{R}(t) = \frac{gL_m e_1(t)}{I(t)(|e_1(t)| + \delta)}. \quad (21)$$

By analogy, the second sliding mode observer is constructed based on the model (18) and takes the form

$$\begin{aligned} \dot{\hat{x}}_*(t) &= -\frac{k_v}{J}y_1(t) + \frac{k_m}{J}y_2(t) - \frac{M(t)}{J} \\ &\quad + v_{eq}(t) - 0.1e_2(t), \\ \hat{y}_*(t) &= \hat{x}_*(t), \\ e_2(t) &= \hat{y}_*(t) - y_1(t). \end{aligned} \quad (22)$$

The function $v_{eq}(t)$ is given by (10) with $D_* = 1$ and $g > |d_1(t)|$. The function $\hat{M}(t) = -Jd_1(t)$ can be estimated as

$$\hat{M}(t) = \frac{gJ e_2(t)}{|e_2(t)| + \delta}. \quad (23)$$

To construct the third sliding mode observer SO3 estimating the function $d_s(t)$, the model (17) should be used since $R_*D_s = 0$ for this model while $R_*D_s = 1$ for the model (18). The description of the observer is similar to (20):

$$\begin{aligned} \dot{\hat{x}}_*(t) &= -\frac{k_w}{L_m}y_1(t) - \frac{R_m}{L_m}y_2(t) + \frac{k_u}{L_m}u(t) \\ &\quad + v_{eq}(t) - 0.1e_1(t), \\ \hat{y}_*(t) &= \hat{x}_*(t), \\ e_1(t) &= \hat{y}_*(t) - y_2(t). \end{aligned}$$

The function $v_{eq}(t)$ is given by (15) with $J_*D_s = -k_w/L_m$ and $g > |d_s(t)|$. The function $\hat{\omega}(t) = d_s(t)$ can be estimated as

$$\hat{\omega}(t) = \frac{ge_1(t)}{|e_1(t)| + \delta}. \quad (24)$$

Thus, due to the use of SO1, SO2, and SO3, it is possible to provide estimates of the errors in the signals received from the speed sensor and the deviations of the thruster parameters from their nominal values due to the faults. It is important to note that the use of the reduced models (7) and (13) makes it possible to construct simple first-dimensional observers. Note that the method suggested by Tan and Edwards (2003) for sensor fault identification produces a three-dimensional observer.

The structural diagram of the synthesized fault diagnosis system for the UV thrusters is shown in Fig. 1. For simulation, consider the system (16) and the observers (20) and (22) with the following UV thruster parameters: $k_v = 67.5610 \cdot 10^{-5}$ Nms/rad; $J = 0.025$ kgm²; $R_m = 0.65 \Omega$; $L_m = 0.00026$ H; $k_w = 0.135$ Vs/rad; $k_u = 27.71$; $k_m = 0.135$ Nm/A; $D = 0.178$ m;

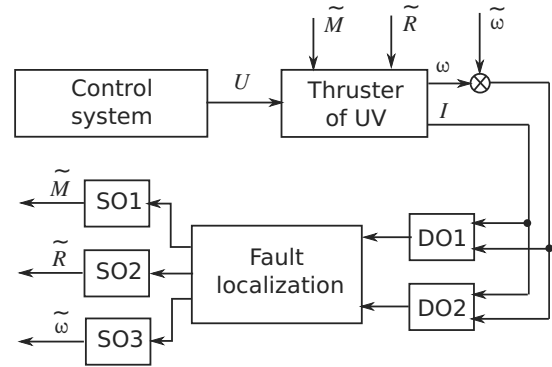

Fig. 1. System of fault diagnosis of the UV thrusters.

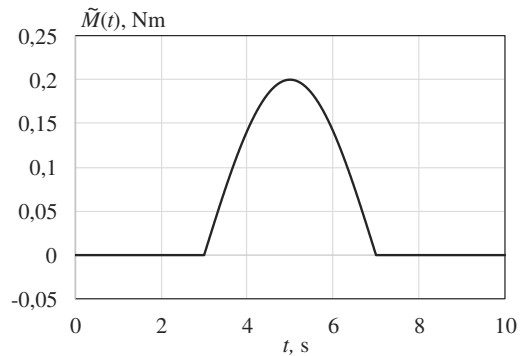

Fig. 2. Estimate of the function $\tilde{M}(t)$.

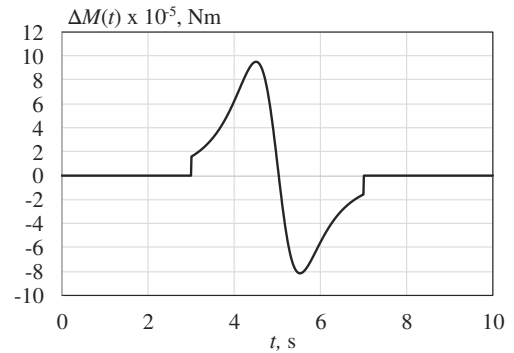

Fig. 3. Estimation error $\Delta M(t)$.

$k_1 = 0.015$; $k_2 = 0.02$; $k_3 = 0.0002$; $k_4 = -0.02$; $\rho = 1030$ kg/m³. The observer (20) has the following parameters: $k = 0.1$, $g = 5000$, and $\delta = 1$; the observer (22) $k = 0.1$, $g = 100$, and $\delta = 0.01$; the third observer $k = 0.1$, $g = 1$, and $\delta = 1$.

The thruster is controlled by the input $u(t) = 5 + \sin(t)$, and single faults are simulated as follows: $d_1(t)$ by introducing the external torque to $\tilde{M}(t) = 0.2 \sin((t - 3)\pi/4)$ Nm on the interval from 3 to 7 s, $d_2(t)$ by a smooth change in active resistance 0.1Ω on the interval from 5 to 10 s, and $d_s(t)$ by introducing the constant error $\tilde{\omega}(t) = 0.2$ rad/s in the readings of the speed sensor on the

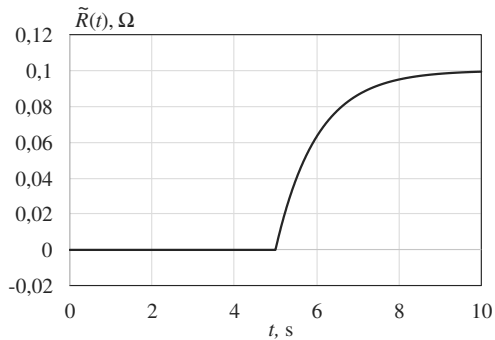

Fig. 4. Estimate of the function $\tilde{R}(t)$.

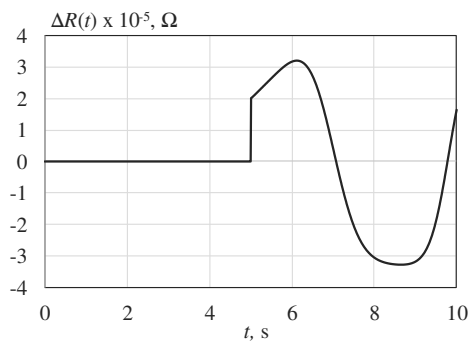

Fig. 5. Estimation error $\Delta R(t)$.

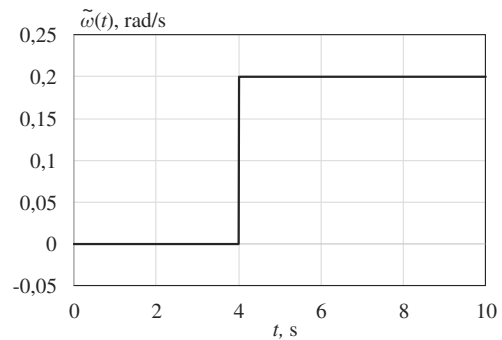

Fig. 6. Estimate of the function $\tilde{\omega}(t)$.

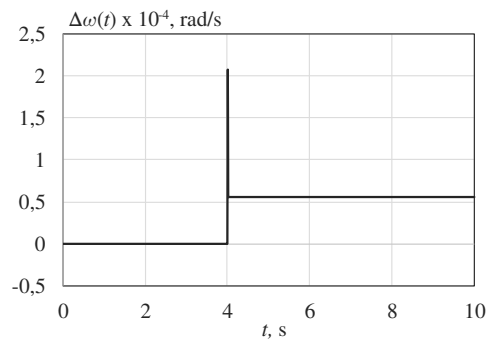

Fig. 7. Estimation error $\Delta\omega(t)$.

interval 4 to 10 s.

Figures 2 and 3 present the estimate of the function $\tilde{M}(t)$ according to (23) and the estimation error, respectively. Figures 4 and 5 show similar graphs for the estimate of the function $\tilde{R}(t)$ according to (21) and its estimation error, respectively; Figures 6 and 7 display the estimate of the function $\tilde{\omega}(t)$ and the appropriate estimation errors. We can see from these figures that the constructed observers allow us to determine the time of the faults the appearance and also to provide rather accurate estimates of the appropriate functions. The identification errors in all three cases do not exceed 0.1%.

Thus, the simulation results show the efficiency and high quality of the synthesized observers. In all the cases considered, it was possible to timely detect the fact of the appearance of the faults, as well as to provide estimates of their values. Based on the discussed approach to the construction of the fault diagnosis system for the UV thruster, highly reliable UV control systems can be created.

6. Conclusion

The problem of fault diagnosis in the UV thrusters has been studied. The synthesized fault diagnosis system using the two-stage method considered in the paper is simple and has low computational complexity that

allows us to implement such diagnosis system on typical on-board computers of the UVs.

The constructed observers provide not only the timely detection and isolation of the arising typical faults using a bank of the DOs, but also accurate estimates of the error in the signals received from the speed sensor and the deviations of the thrusters parameters from their nominal values due to the faults appearance. The simulation results confirm the efficiency and high quality of the synthesized observers but further investigations before possible implementation are required.

Acknowledgment

The paper was supported through grants of the Russian Scientific Foundation, 16-19-00046-P (*Methods of Constructing Sliding Mode Observers*), and through grants of the Russian Foundation for Basic Research, 20-38-70161 (*Synthesis of Observers for Diagnosis*).

References

- Alwi, H. and Edwards, C. (2008). Fault tolerant control using sliding modes with on-line control allocation, *Automatica* **44**(7): 1859–1866, DOI: 10.1016/j.automatica.2007.10.034.
- Bartoszewicz, A. and Adamiak, K. (2019). A reference trajectory based discrete time sliding mode control

- strategy, *International Journal of Applied Mathematics and Computer Science* **29**(3): 517–525, DOI: 10.1515/amcs-2019-0038.
- Blanke, M., Kinnaert, M., Lunze, J. and Staroswiecki, M. (2006). *Diagnosis and Fault-Tolerant Control*, Springer, Berlin.
- Byrski, W., Drapała, M. and Byrski, J. (2019). An adaptive identification method based on the modulating functions technique and exact state observers for modeling and simulation of a nonlinear MISO glass melting process, *International Journal of Applied Mathematics and Computer Science* **29**(4): 739–757, DOI: 10.2478/amcs-2019-0055.
- Chirikjian, G. (2009). Robotic self-replication, self-diagnosis, and self-repair: Probabilistic considerations, in H. Asama et al. (Eds), *Distributed Autonomous Robotic Systems 8*, Springer, Berlin/Heidelberg, pp. 273–281, DOI: 10.1007/978-3-642-00644-9_24.
- Daidola, J. and Johnson, F. (1992). *Propeller Selection and Optimization Program*, Manual for the Society of Naval Architects and Marine, New York, NY.
- Davila, J., Fridman, L. and Poznyak, A. (2006). Observation and identification of mechanical systems via second order sliding modes, *International Journal of Control* **79**(10): 1251–1262, DOI: 10.1080/00207170600801635.
- Edwards, C., Alwi, H. and Tan, C.P. (2012). Sliding mode methods for fault detection and fault tolerant control with application to aerospace systems, *International Journal of Applied Mathematics and Computer Science* **22**(1): 109–124, DOI: 10.2478/v10006-012-0008-7.
- Edwards, C. and Spurgeon, S. (1994). On the development of discontinuous observers, *International Journal of Control* **59**(5): 1211–1229, DOI: 10.1080/00207179408923128.
- Edwards, C., Spurgeon, S. and Patton, R. (2000). Sliding mode observers for fault detection and isolation, *Automatica* **36**(4): 541–553, DOI: 10.1016/S0005-1098(99)00177-6.
- Escobet, T., Bregon, A., Pulido, B. and Puig, V. (2019). *Fault Diagnosis of Dynamic Systems*, Springer, Berlin.
- Filaretov, V., Zhirabok, A., Zuev, A. and Protchenko, A. (2012). The development of the faults accommodation system for actuators of multilink manipulators, *Proceedings of the 23rd DAAAM International Symposium on Intelligent Manufacturing and Automation, Vienna, Austria*, pp. 575–578.
- Fridman, L., Levant, A. and Davila, J. (2007). Observation of linear systems with unknown inputs via high-order sliding modes, *International Journal of Systems Science* **38**(10): 773–791, DOI: 10.1080/00207720701409538.
- Gertler, J. (1998). *Fault Detection and Diagnosis in Engineering Systems*, Marcel Dekker, New York, NY.
- He, J. and Zhang, C. (2012). Fault reconstruction based on sliding mode observer for nonlinear systems, *Mathematical Problems in Engineering* **2012**(2): 1–22, DOI: 10.1155/2012/451843.
- Inzarcev, A., Kiselev, L. and Kostenko, V. (2018). *Underwater Robotics: Systems, Technologies, Application*, IMTP FEB RAS, Vladivostok, (in Russian).
- Kalsi, K., Hui, S. and Zak, S. (2011). Unknown input and sensor fault estimation using sliding-mode observers, *Proceedings of the American Control Conference, San Francisco, CA, USA*, pp. 1364–1369.
- Mironovsky, L. (1998). *Functional Diagnosis of Dynamic Systems*, Nauka, Moscow, (in Russian).
- Pisarets, A., Zhirabok, A. and Inzartsev, A. (2004). On diagnosis for thrusters of underwater vehicles, *Proceedings of the Sixth ISOPE Pacific/Asia Offshore Mechanics Symposium, Vladivostok, Russia*, pp. 255–259.
- Rascón, R., Rosas, D. and Hernandez-Balbuena, D. (2017). Regulation control of an underactuated mechanical system with discontinuous friction and backlash, *International Journal of Applied Mathematics and Computer Science* **27**(4): 785–797, DOI: 10.1515/amcs-2017-0055.
- Sarkar, N., Podder, T. and Antonelli, G. (2002). Fault-accommodating thruster force allocation of an AUV considering thruster redundancy and saturation, *IEEE Transactions on Robotics and Automation* **18**(2): 223–233, DOI: 10.1109/TRA.2002.999650.
- Simani, S., Fantuzzi, C. and Patton, R. (2002). *Model-based Fault Diagnosis in Dynamic Systems Using Identification*, Springer, Berlin.
- Tan, C. and Edwards, C. (2003). Sliding mode observers for robust detection and reconstruction of actuator and sensor faults, *International Journal of Robust and Nonlinear Control*, **13**(5): 443–463, DOI: 10.1002/rnc.723.
- Utkin, V. (1992). *Sliding Modes in Control Optimization*, Springer, Berlin.
- Wang, J. (2012a). Fault diagnosis of underwater vehicle with FNN, *Proceedings of the 10th World Congress on Intelligent Control and Automation, Beijing, China*, pp. 2931–2934, DOI: 10.1109/WCICA.2012.6358371.
- Wang, J. (2012b). Fault diagnosis of underwater vehicle with neural network, *Proceedings of the 24th Chinese Control and Decision Conference (CCDC), Taiyuan, China*, pp. 1613–1617, DOI: 10.1109/CCDC.2012.6243012.
- Wang, J., Wu, G., Wan, L., Sun, Y. and Jiang, D. (2009). Recurrent neural network applied to fault diagnosis of underwater robots, *Proceedings of the IEEE International Conference on Intelligent Computing and Intelligent Systems, Shanghai, China*, pp. 593–598, DOI: 10.1109/ICICISYS.2009.5357773.
- Zhang, M., Wu, J. and Wang, Y. (2011). Simultaneous faults detection and location of thrusters and sensors for autonomous underwater vehicle, *Proceedings of the 4th International Conference on Intelligent Computation Technology and Automation, Shenzhen, China*, pp. 504–507, DOI: 10.1109/ICICTA.2011.139.
- Zhao, B., Skjetne, R., Blanke, M. and Dukan, F. (2014). Particle filter for fault diagnosis and robust navigation of underwater robot, *IEEE Transactions on Control Systems Technology* **22**(6): 2399–2407, DOI: 10.1109/TCST.2014.2300815.

- Zhirabok, A., Shumsky, A., Solyanik, S. and Suvorov, A. (2017). Fault detection in nonlinear systems via linear methods, *International Journal of Applied Mathematics and Computer Science* **27**(2): 261–272, DOI: 10.1515/amcs-2017-0019.
- Zhirabok, A., Zuev, A. and Shumsky, A. (2019). Diagnosis of linear systems based on sliding mode observers, *Journal of Computer and Systems Sciences International* **58**(6): 898–914, DOI: 10.1134/S1064230719040166.
- Zhirabok, A., Zuev, A. and Shumsky, A. (2020a). Diagnosis of linear dynamic systems: An approach based on sliding mode observers, *Automation and Remote Control* **81**(2): 345–358, DOI: 10.1134/S0005117920020022.
- Zhirabok, A., Zuev, A. and Shumsky, A. (2020b). Identification of faults in the sensors of technical systems with the use of sliding mode observers, *Measurement Techniques* **62**(10): 869–878, DOI: 10.1007/s11018-020-01707-1.
- Zhu, D. and Sun, B. (2013). Information fusion fault diagnosis method for unmanned underwater vehicle thrusters, *IET Electrical Systems in Transportation* **3**(4): 102–111, DOI: 10.1049/iet-est.2012.0052.



Alexander Zuev is the head of a laboratory in the Institute for Marine Technology Problems, Russian Academy of Sciences (Vladivostok). He received his PhD degree in automatic control from the Institute of Automation and Control Processes, Russian Academy of Sciences (Vladivostok) in 2011. His research interests include nonlinear control theory with application to fault diagnosis and fault tolerant control.



Alexey Zhirabok is a professor at Far Eastern Federal University (Vladivostok). He received his PhD degree in radiolocation and radionavigation from Leningrad Electrotechnical Institute in 1978 and his DSc degree in automatic control from the Institute of Automation and Control Processes, Russian Academy of Sciences (Vladivostok) in 1996. His research interests include nonlinear control theory with application to fault diagnosis and fault tolerant control.



Vladimir Filaretov is the head of a laboratory in the Institute of Automation and Control Processes, Russian Academy of Sciences (Vladivostok). He received his PhD degree from State Technical University named after Bauman (Moscow, Russia) in 1976 and his DSc degree in automatic control from Saint-Petersburg State Technical University (Russia) in 1990. His research interests include adaptive and optimal control systems of complicated nonlinear systems of automatic control with unknown and varying parameters, industrial and underwater robots and also other dynamic systems, allowing automation of technical devices and technological processes.

Received: 27 March 2020

Revised: 23 June 2020

Accepted: 13 July 2020